

# ASCLEPIUS

The product is a Virtual Electronic  
Anatomy Table for education only.

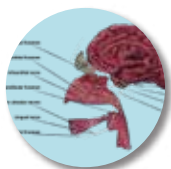

Anatomy



Radiology

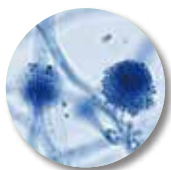

Histopathology Atlas



CTRender

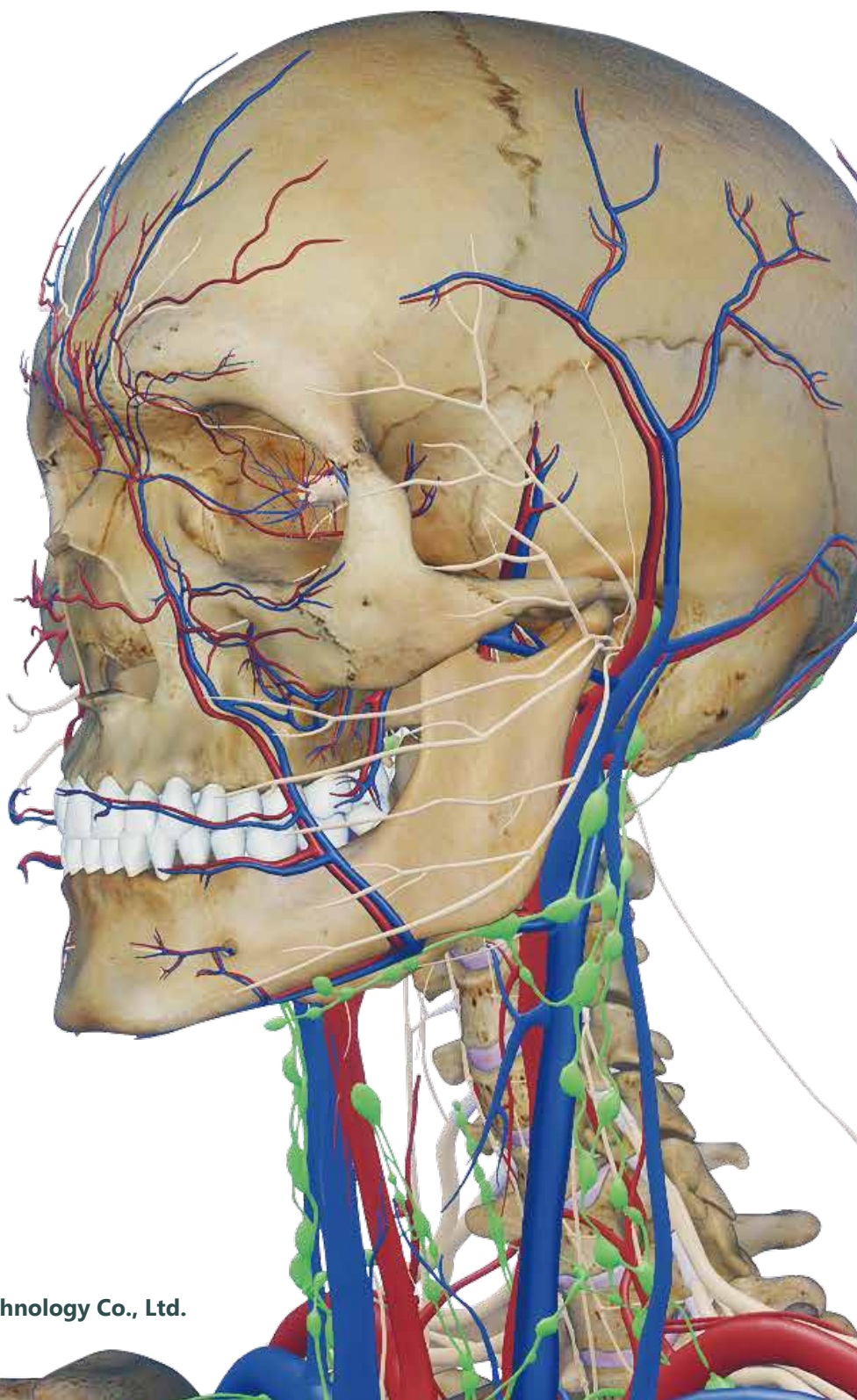



# Digitalize Your Anatomy Education

## *A* Perfect Teaching Aid

Asclepius has proved itself to be the best teaching aid a student can have. With a fully annotated human anatomy and the ability to read CT/MRI data and create 3D models with the data. The Asclepius is becoming a popular tool in medical education. The ability to perform any kind of dissection on the Asclepius enables the student to easily understand and visualize the complex structures of the human body. The Asclepius is also a great tool for professors in medical universities. Since the Asclepius can be used as a video output to teach a large group of students at once. Every student will get to see and understand the human anatomy through the Asclepius.

## *A* Breakthrough in Teaching

Asclepius assist medical institutions in reducing yearly expense on real human cadavers. The re-usable content of the Asclepius makes it a lot simpler and sustainable for students and professors to perform virtual dissections of the virtual human cadaver as many times as they want, unlike a real human cadaver.

## *A* Environmentally Friendly

Asclepius offers a similar experience like that of a cadaver lab, but without the harmful chemicals and the stinky environment. There is no concern about exposure to radiation or other chemicals that can harm students physically.

# A Comparison with Traditional anatomy lab

	Asclepius	Traditional anatomy lab
Harmful Chemicals	No	Yes
Facility Requirements	No special requirement	Specially Designed Lab
Regulations	None required	Requires special permissions
Cost	One time	Regularly need to buy human cadavers

# A Usage Scenario

## TBK-43 LT

TBK 43 LT is a smaller size, making it more portable. For easy use in classrooms for students to get hands-on experience with virtual anatomy.



TBK-43 LT



TBK-65 4K

## TBK-65 4K

The TBK-65 4K has the ability to be tilted from horizontal to wallboard mode. It is suitable in assisting professors and lecturers with demonstrating human anatomy to a bigger class.

## TBK-84 | TBK-84 EA TBK-99 | TBK-99 EA

TBK 84/99 is the center of attraction because of its life sized human cadaver view. TBK 84/99 can be placed into a virtual anatomy lab where it can be used by wither the professors or students to perform virtual dissection of the virtual human cadaver as many times as they want.



TBK-84 | TBK-99



TBK-84 EA | TBK-99 EA

# Utilization

## Fully Tech Lab



Asclepius is replacing real anatomy labs with the virtual anatomy labs enhancing the abilities of the students and professors. With detailed realistic human anatomy and information about several body systems the Asclepius is more than just a virtual cadaver. The RADIOLOGY software also helps the students and professors rehearse pre-surgical planning before going in to the real-life surgical situations.

## Lecture



Asclepius' intended use is in assisting professors in demonstrating simple to advanced medical concepts in medical institutions and colleges. Using the Asclepius professors can connect it to monitors or projectors to perform a lecture to a small or large group of students. The pre-loaded data in the Asclepius assists professors in instructing class. It also provides a unique way for students to memorize and visualize human organs, both externally and internally. The professors can also prepare their own teaching material to teach the students.

## RADIOLOGY



The software package of the Asclepius helps the surgeons, professors, and students to train themselves with pre-surgical planning by reading CT, MRI, or DICOM data files and converting it into a 3D model in less than 30 seconds.

## Remote access



The Asclepius series is equipped with tools to access the table remotely from any location. Providing flexibility to professors and instructors to use the Asclepius virtually from home as well.

# Anatomy Features

## Fully Annotated Human Anatomy

Asclepius is equipped with a life-sized male and female human cadaver with full annotations throughout the entire body of the virtual cadaver. The table is equipped with the different planes of view, i.e., coronal, sagittal and transverse, providing the details from all angles of the human body.

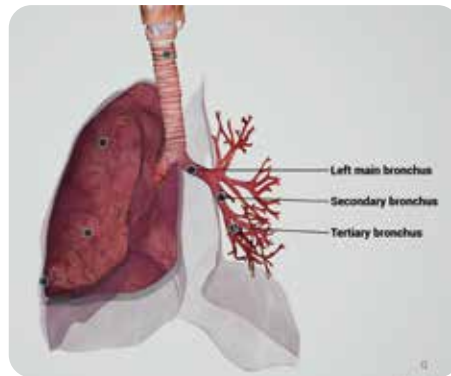
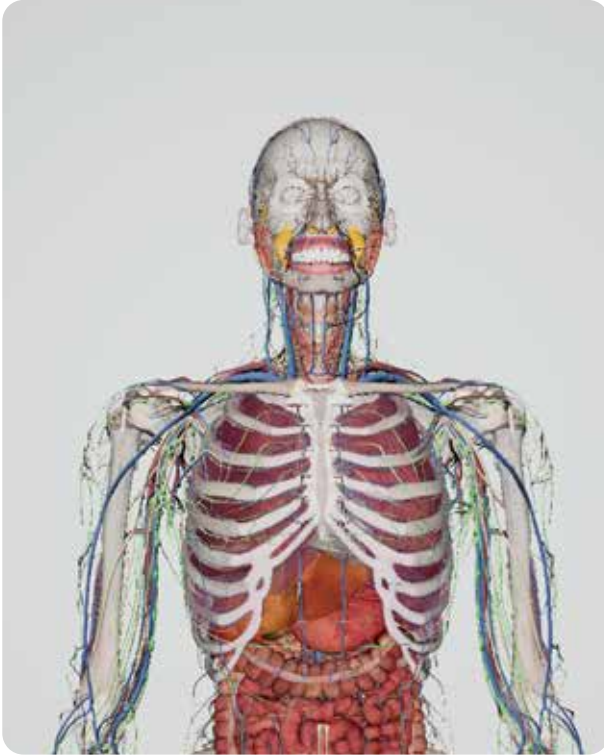

## Systematic anatomy

Asclepius content is divided into 13 sections. Professors can go around each section and teach students each section in detail. For example, working on the reproductive system, respiratory system, and other systems. These segments make it easier for the students to remember the pictorial presentation of each section of the human anatomy.

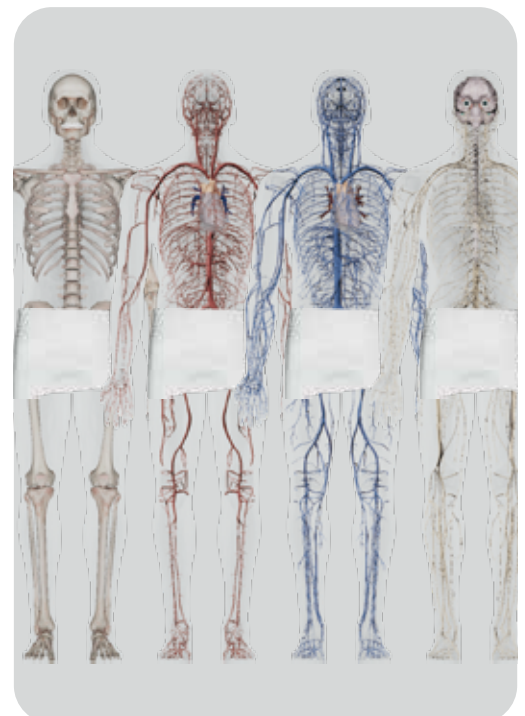

## Virtual Interactive Dissection

The virtual dissection tool of Asclepius is one of the most user-friendly features available among the virtual dissection tables. One touch dissection of the virtual human cadaver with full annotation is available with the Asclepius. Virtual dissection is gradually replacing the traditional anatomy labs in the universities as it is a re-usable virtual cadaver that can be used as many times as one would want.

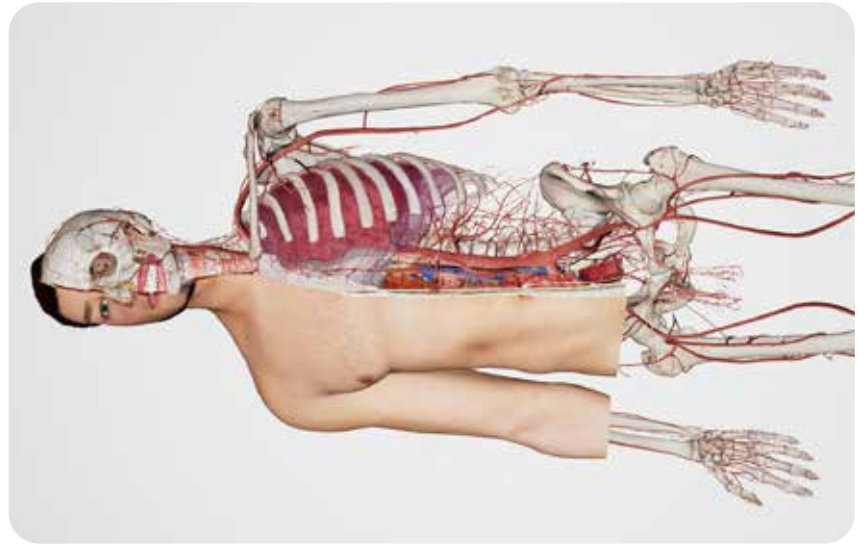
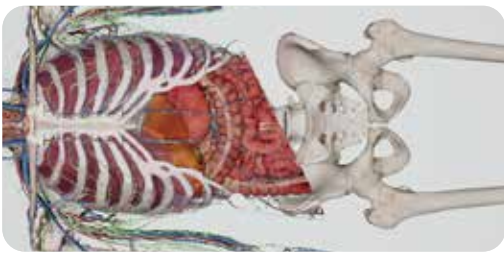

## Free Hand Cut

Free hand cut gives the option to perform the dissection of the virtual human cadaver in form. Professors or students can draw any form to perform the dissection in that respective form.



# Anatomy Features

## Note

Asclepius is equipped with tools for teachers to mark notes or enter texts as notes while teaching. It can also take screenshots and save it into an external USB to be used during other lectures .

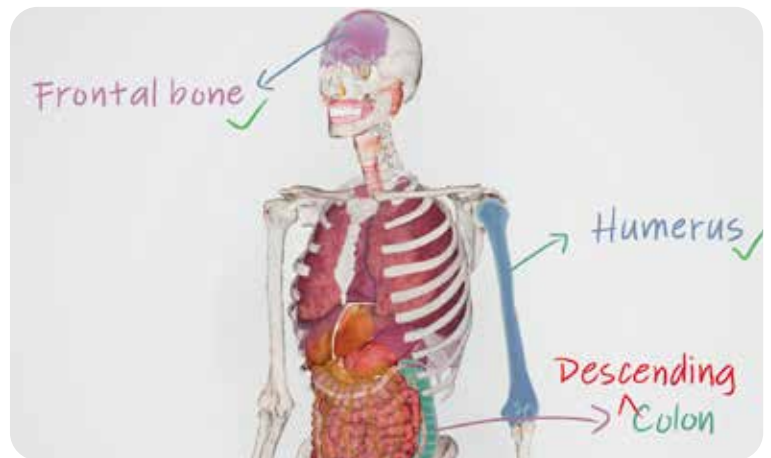

## Embryology Teaching

The embryology teaching instructions, which including illustrations of the fetal development process from gamete formation to August and September. It can be matched with the model teaching instructions to help teachers reduce the time for writing text in the classroom, and can Show more rich and diverse pictures to assist students in the embryonic course content.

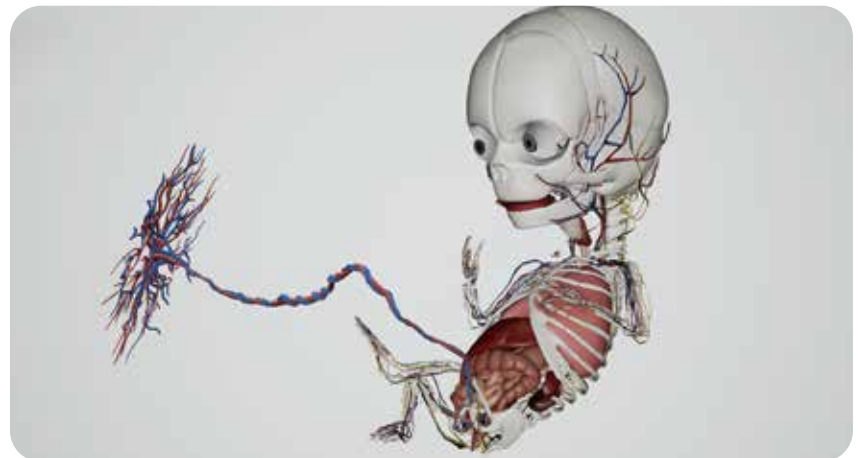
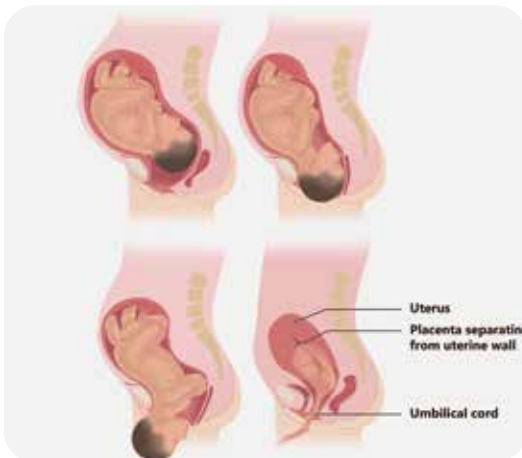

## Change Color

A selected body part can be changed to a specific color to make it more distinct. If the instructor wants to teach a specific body part it will be easier to highlight the body part. For example, if a lecturer wants to teach External Oblique, the lecturer can select all three regions of the external oblique and change it to a different color.

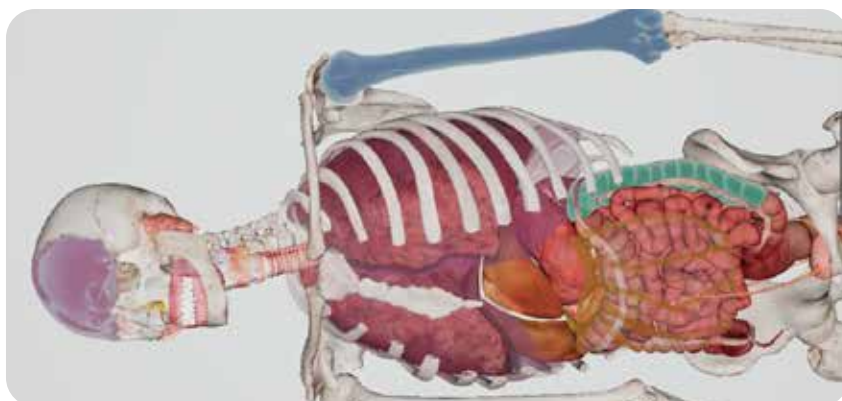



## Organ animation

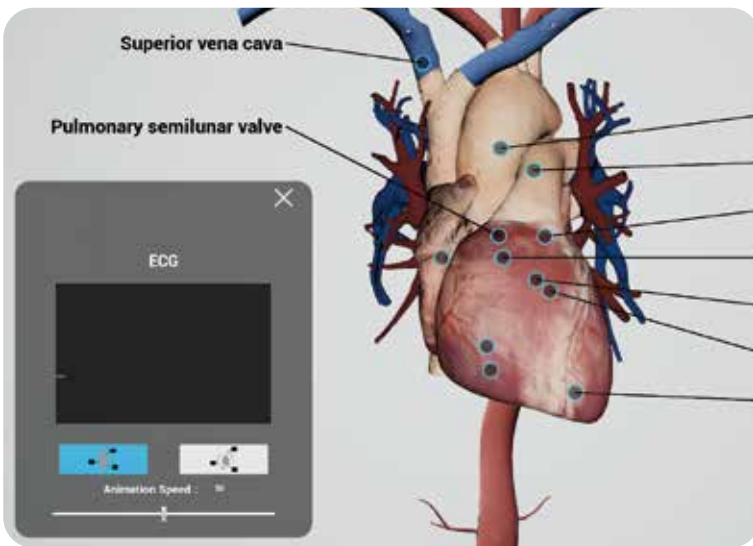

Asclepius is equipped to show the animations of the heart with full annotations describing each part of the heart. With the ability to view the sagittal, coronal, and transverse view of the heart, the users can gain a deeper understanding of how the heart functions.

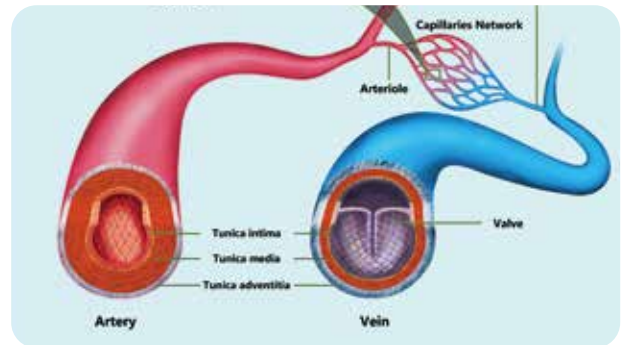

## Animal Anatomy

Asclepius contains the animal scans to perform the comparative study with the human and animal anatomy for educational purpose.

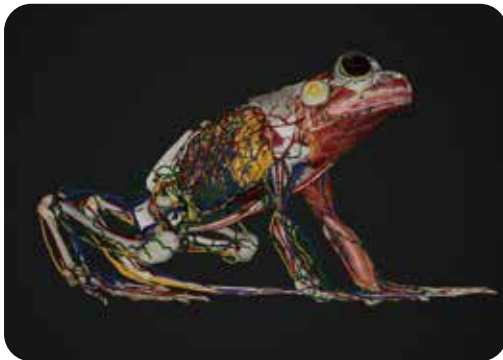

## Regional Anatomy

Along with a full human anatomy, Asclepius also comes with the regional anatomy of the body, providing even more detail to understanding the human body. The regional anatomy of the body is divided into chest, ankle, elbow, thighs and more.

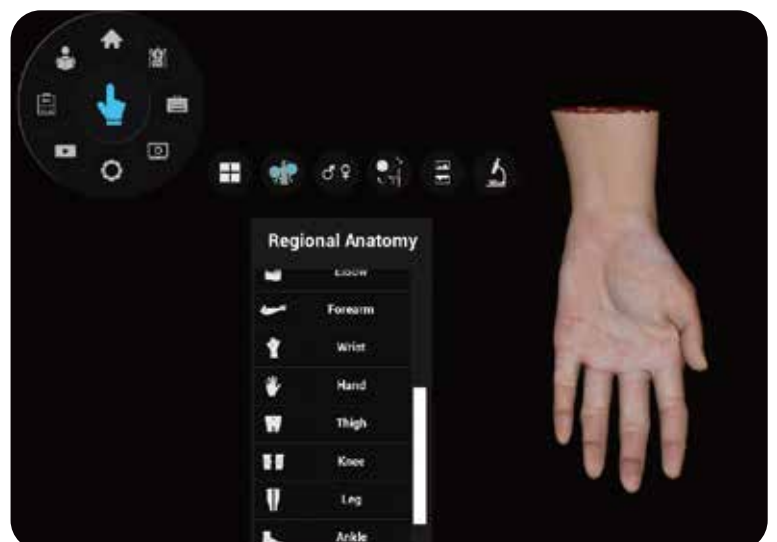
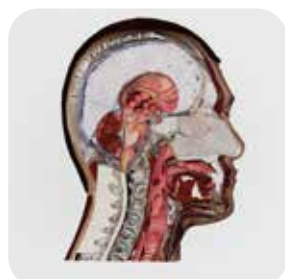

# Anatomy Features

## Multiple choice exam

Asclepius comes pre-loaded with more than 12,000 quizzes covering the whole medical curriculum.

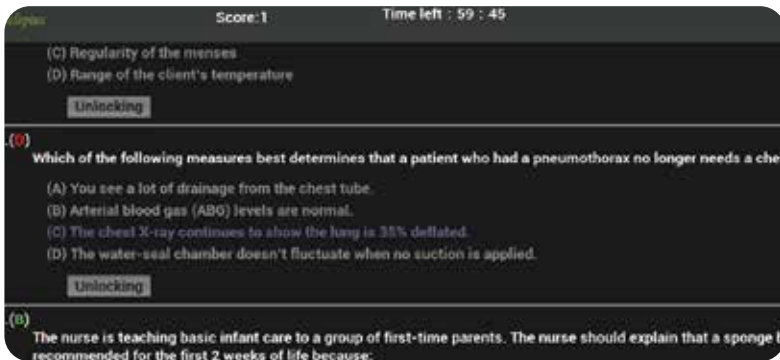

## Quiz

Asclepius comes with a pre-installed quiz for professors to check their student's understanding of the content. Asclepius also provides a cloud-based system where professor's can design their own questionnaire and use it to evaluate the students.

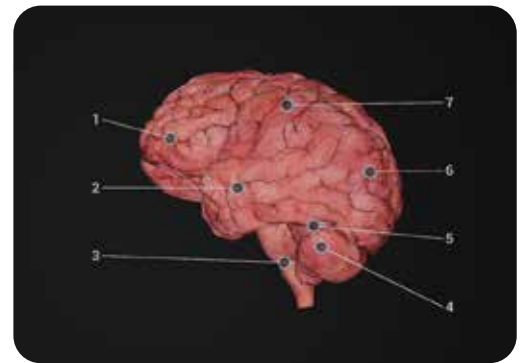

## Virtual Scope Teaching Mode

Endoscope teaching mode gives the professors, students, and instructors the advantage of traveling through the hollow organs of the human body. This feature comes with the ability to zoom in, zoom out, illuminate, adjust the aperture, and the change the movement rate.

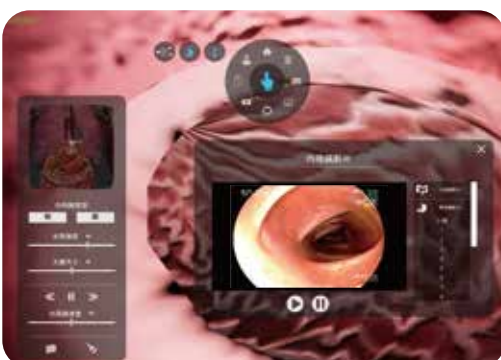

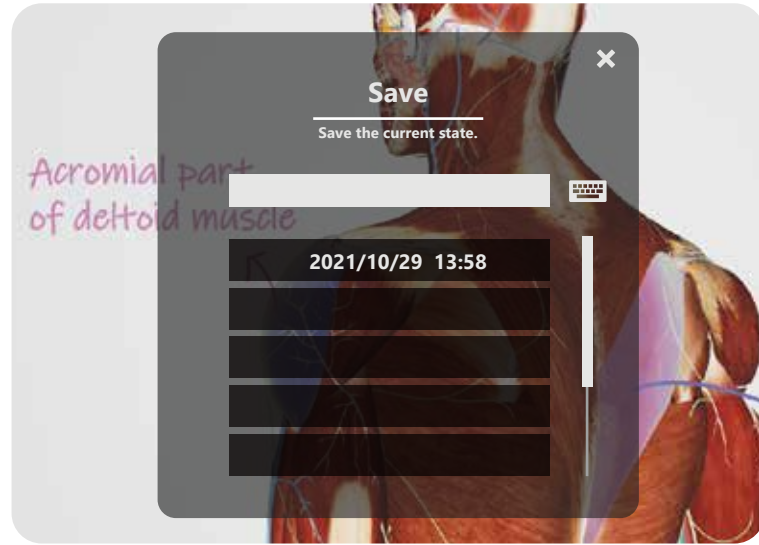

## Save the current state

Asclepius allows professors to save their current teaching session on the screen they can pick up where they left off when teaching the next lesson.

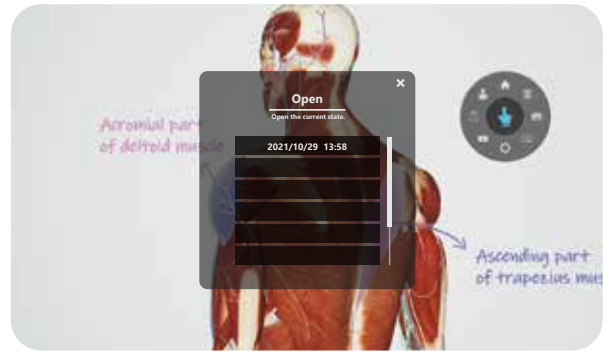

## SPLIT SCREEN FUNCTION

Two of software will be displayed at the same time, allowing users to watch two software screens at the same time. The function of splitting the screen is selected according to the user's needs, providing a rich variety of software.

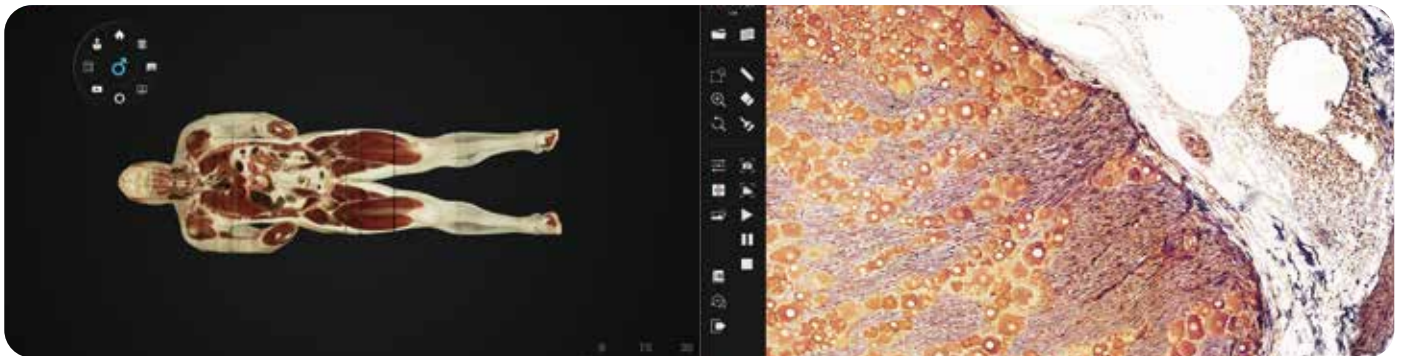

## 3 Axis Display Mode

The possibility of viewing the sagittal, coronal, and transverse views comes in handy with the Asclepius. With the control bar, it provides professors and instructors full control over the point of view of the human anatomy.

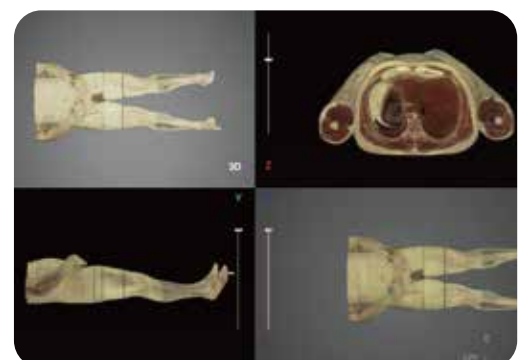
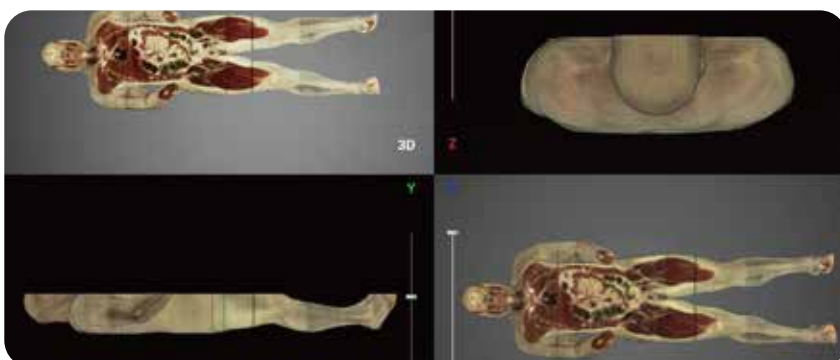

# Radiology Features



ASCLEPIUS

## Radiology

Spine	Pelvis	Tibia
Shoulder	Femur	Teeth
Skull	Palm	Foot

Radiological Viewer Provide  
Hard tissue examples and soft tissue examples, including CT and MR DICOM image.

Radiology is an educational application software system for audio-visual imaging. It provides image applications in DICOM medical image format. It can read 3D image models with CT, MRI and do 2D to 3D image conversion operations. Radiology provides visual analysis of DICOM data and 2D/3D image conversion for biomedical engineering education, digital medical image viewing, and image model simulation analysis.

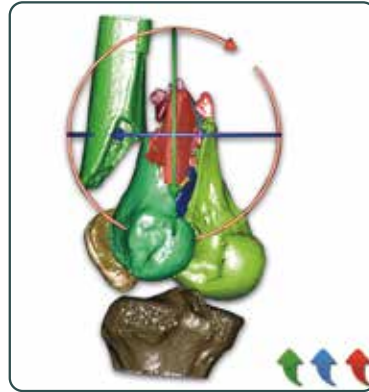

## Image Tool

Radiology provides basic operation and multiple image features. Such as, image processing, image rendering, image measurement, drawing tools, duplication, including 3D image area split, and cutting and applying objects and images in the simulator suitable for general use of medical imaging operation.

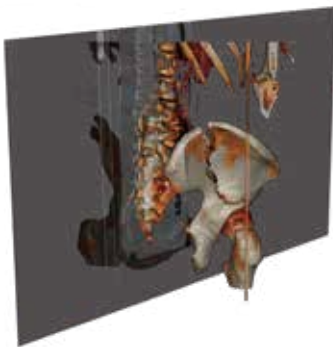

## Simulation of pre-surgical planning for education



Radiology is dedicated as a software system for orthopedic medical imaging and educational applications. It has developed a number of digital image simulation operations and visual image operations. Radiology's core function is to simulate pre-surgical planning of digital images to educate the future doctors and surgeons.

# Radiology Features



## Simulation

- ▣ Spinal puncture path planning simulation
- ▣ General/customized bone plate planning simulation
- ▣ Screw locking / SI locking screw / screw implant planning simulation
- ▣ Manual reset / automatic symmetrical reset planning simulation

## Reading

- ▣ CT
- ▣ MRI
- ▣ X-Ray
- ▣ C-Arm



Spinal puncture



Bone plate



Dental Screw



Reduction of fracture

# Histopathology Atlas Features

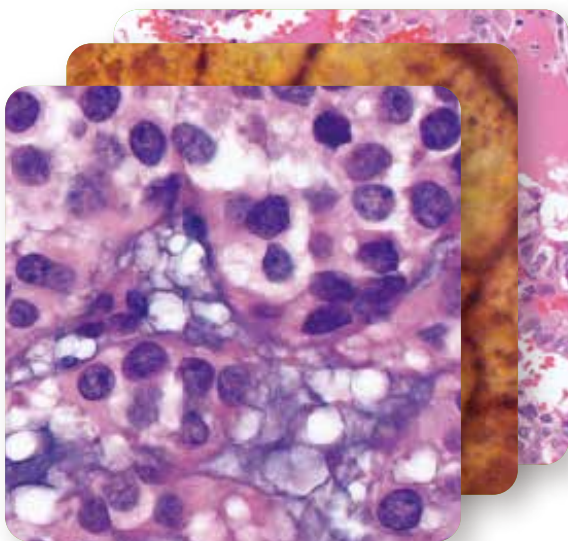
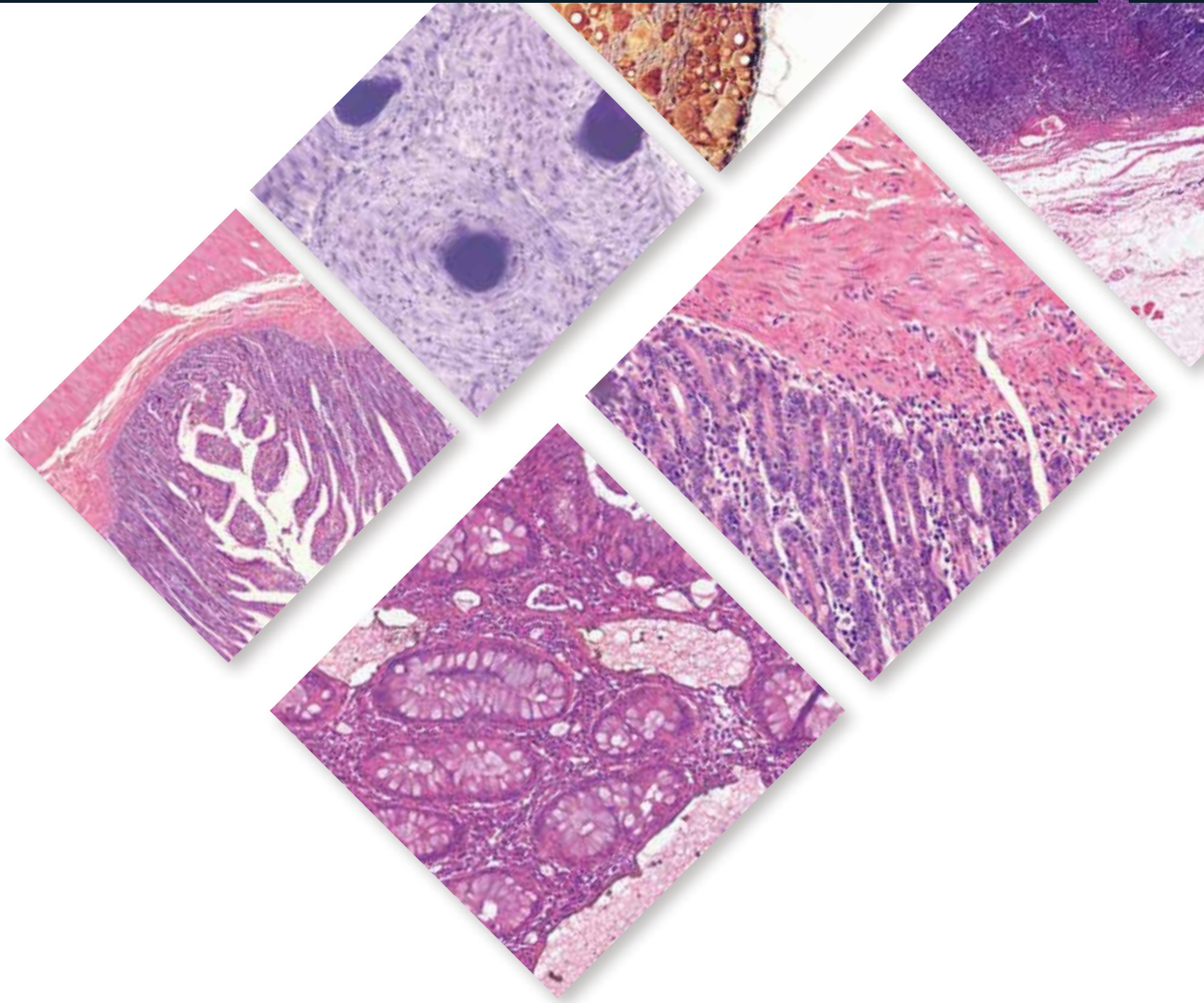

Histopathology Atlas provides an application tool for images and videos. That you can load for operation. Image reading formats support \*.jpg, \*.png, \*.tif, \*.bmp and other image format files. Video reading formats support \*.mkv, \*.mp4, \*.avi, \*.mov and other video format files. The Histopathology Atlas system operation interface includes the selection of Pathology and Histology menu interfaces. The main image operation interface is the display interface of 2D the image. Histopathology Atlas provides a selection of tools to use, including, image list, basic tools, brush tools, image adjustment tools, and note storage functions.

# Histopathology Atlas Features

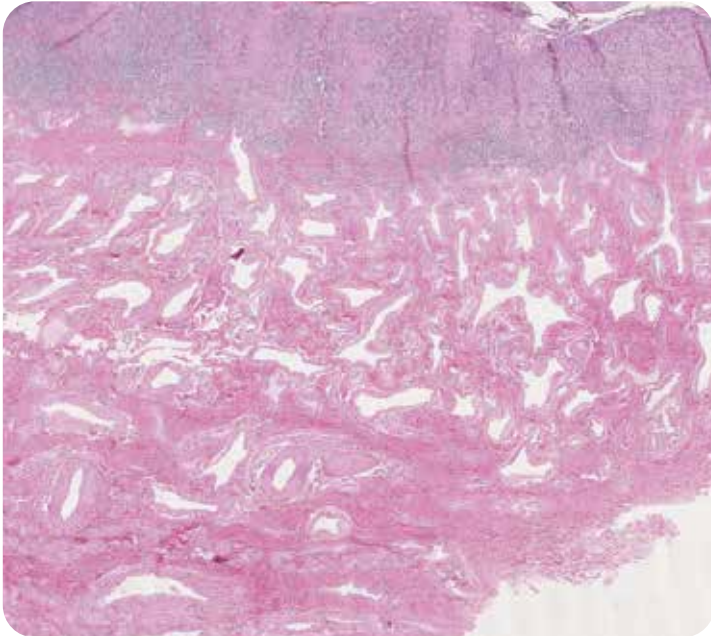

## Annotation

Standard description of the Pathological Case is pre-loaded with the image of the Pathological Case

Squamous cell carcinoma About 95% of penile cancers start in flat skin cells called squamous cells. Squamous cell carcinoma (also known as squamous cell cancer) can start anywhere on the penis. Most of these cancers start on the foreskin (in men who have not been circumcised) or on the glans.

## Amplification

Helps you amplify and enlarge the targeted area to make it more clear and understandable.

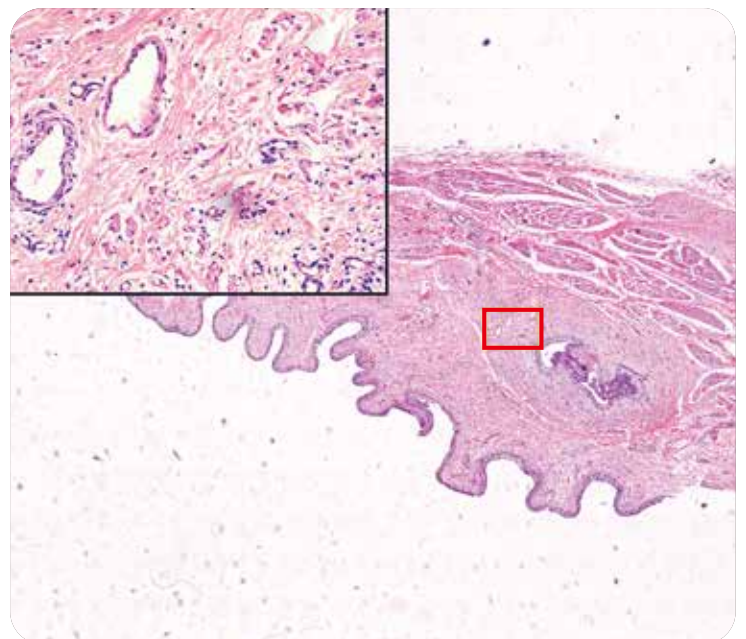
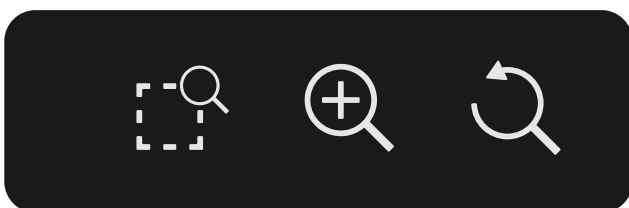



## Pen tool

A marker that assists professors and instructors in putting foot notes on the images and take screenshots for the next classes.

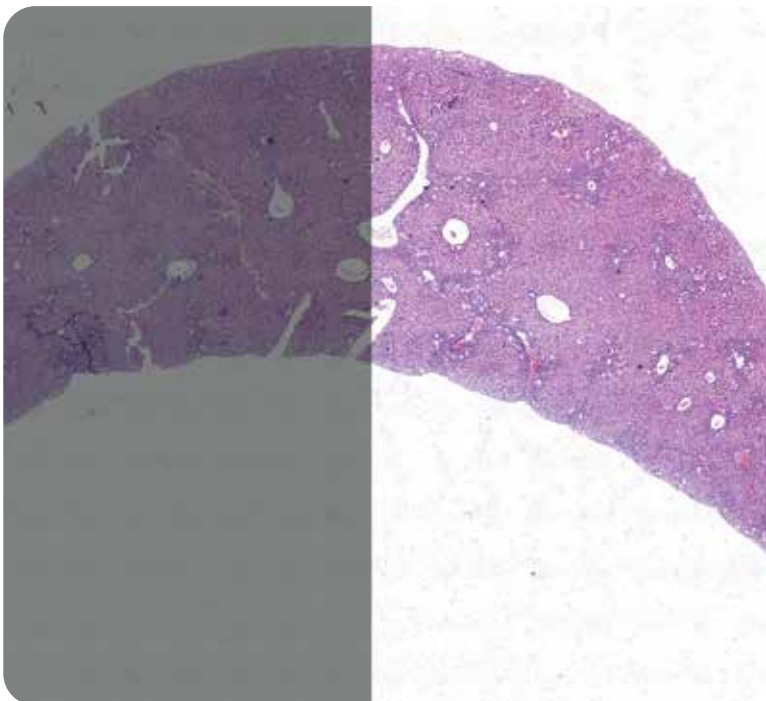
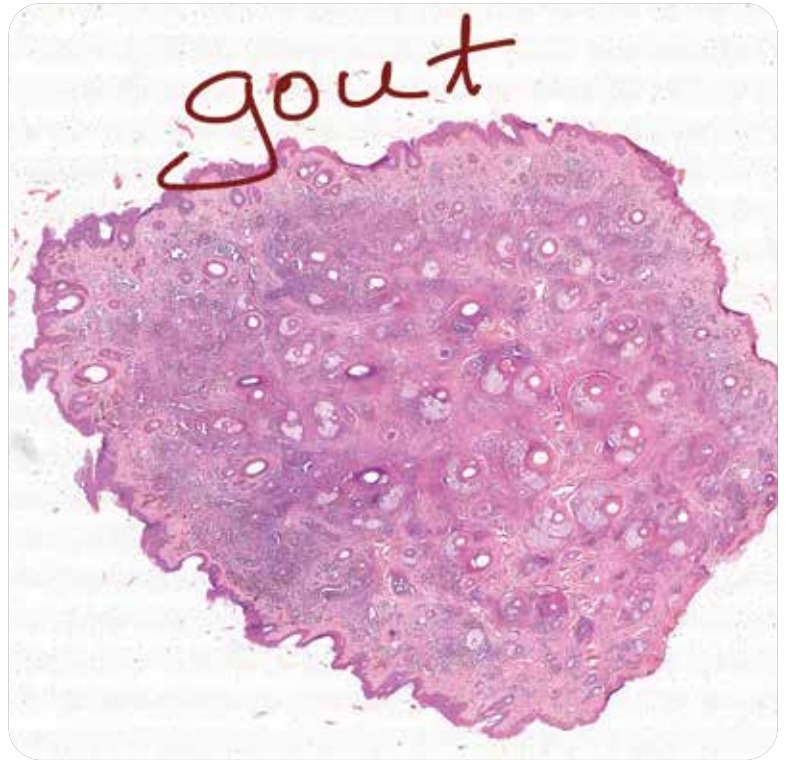
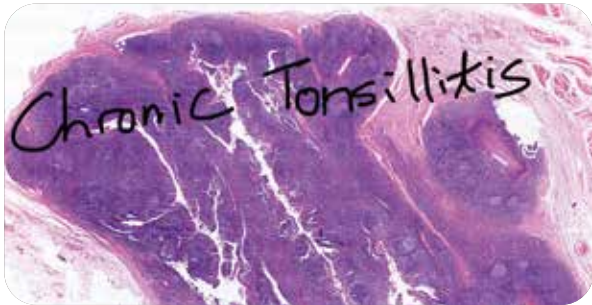

## Image tool

The image tool provides the flexibility to adjust the quality of the image on the screen by adjusting the brightness, contrast or sharpness of the image.

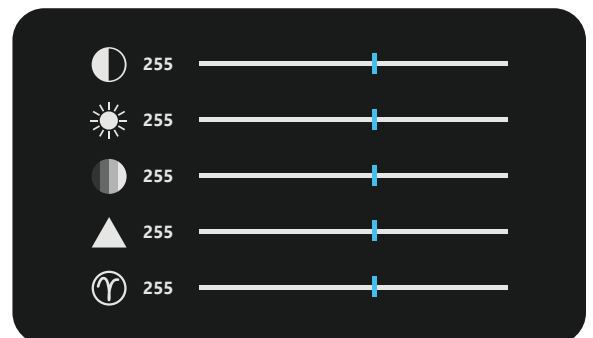

# CTRender Features

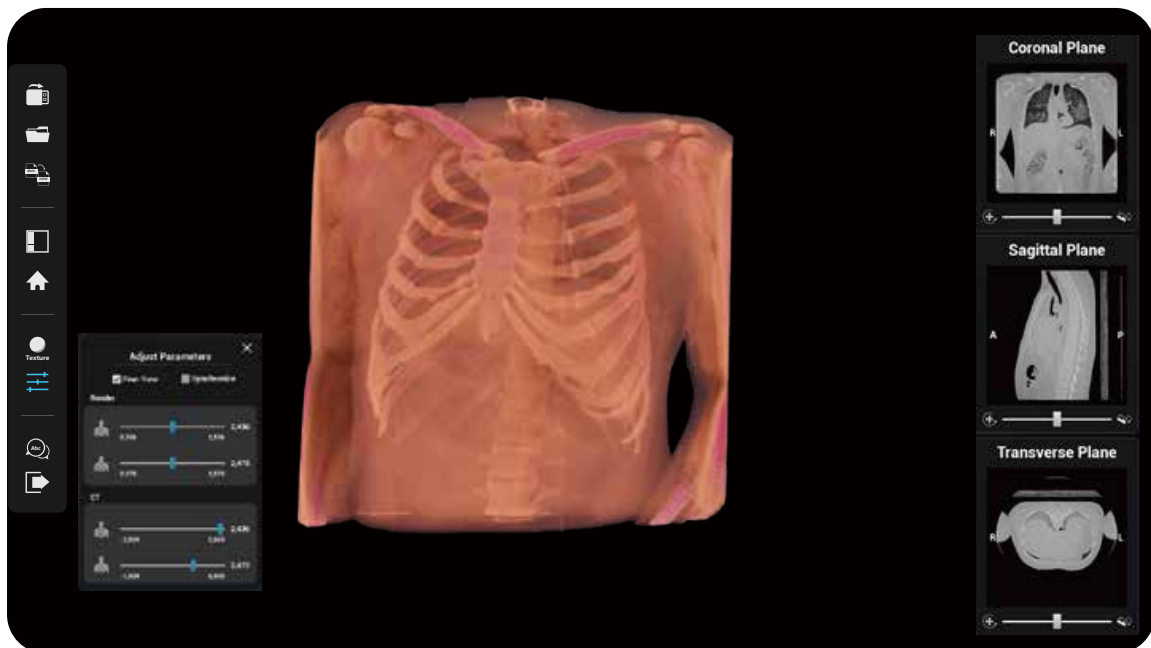

CT Render provide the data visualization technique which creates a 3D representation of DICOM data. CT and MRI data are frequently visualied with volume rendering in addition to other reconstarctions and slices.



DICOM READ



RENDER



INTERFACE



## Interface

The user interface of the medical image renderer is simple and easy to understand. The interface mode can be switched according to the needs of the user. The CT image or the 3D rendering model can be displayed independently, and the CT image and the 3D rendering model can be displayed simultaneously. And provide a three-axis anatomical plane for observation.

## Instant rendering

Immediately after importing DICOM data, the 3D rendering model will be presented. The smaller the DICOM slice spacing, the higher the detail of the 3D rendering model. It can help doctors, teachers and students to better observe the required parts, which is conducive to simulation learning. And the softness in the 3D rendered model, the rendering effect of hard tissue has high fidelity, and it brings easy readability to users.

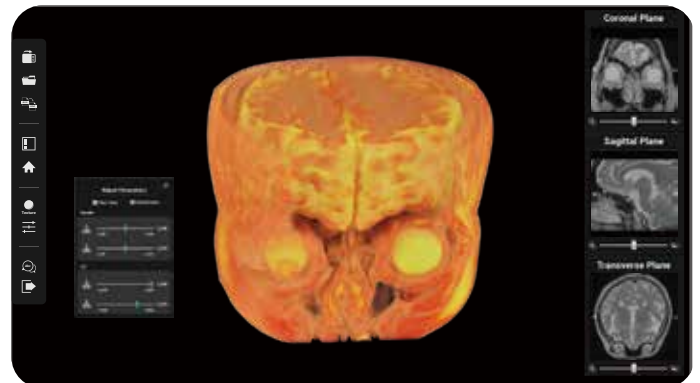

## Renderer

The renderer has a variety of preset rendering modes with rich colors and fine textures. Muscles, fats, bones, blood vessels, etc. are represented by different colors, which can highlight each body system and facilitate observation. Users can also adjust the parameters of the renderer by themselves to achieve the desired visual effect.

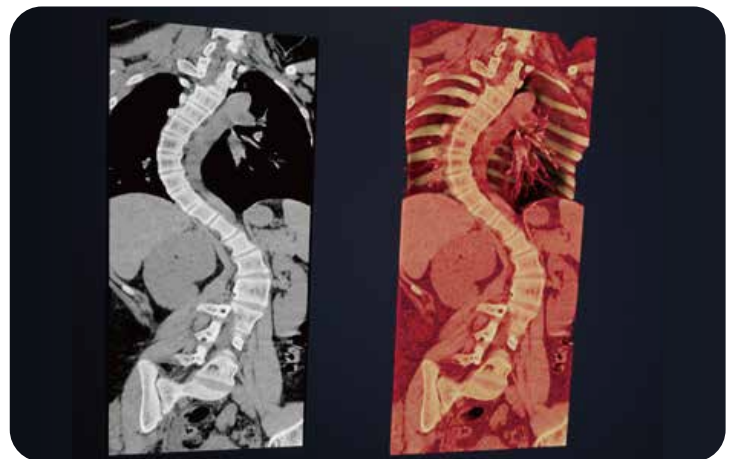
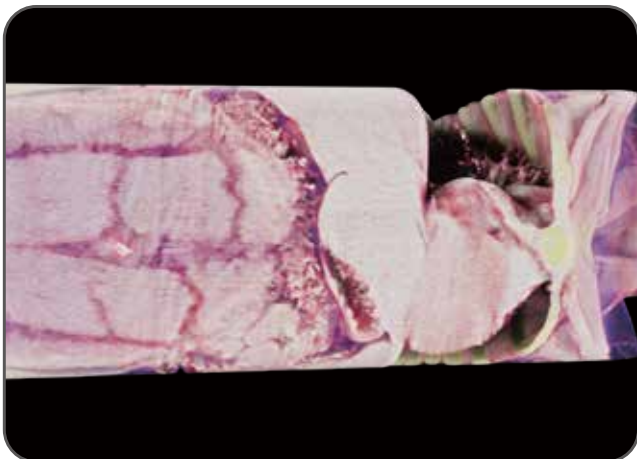

## Combining CT images with 3D rendering models

The medical image renderer allows users to separate or overlap CT images and 3D rendered models. Allows users to better observe the relative position of the two.

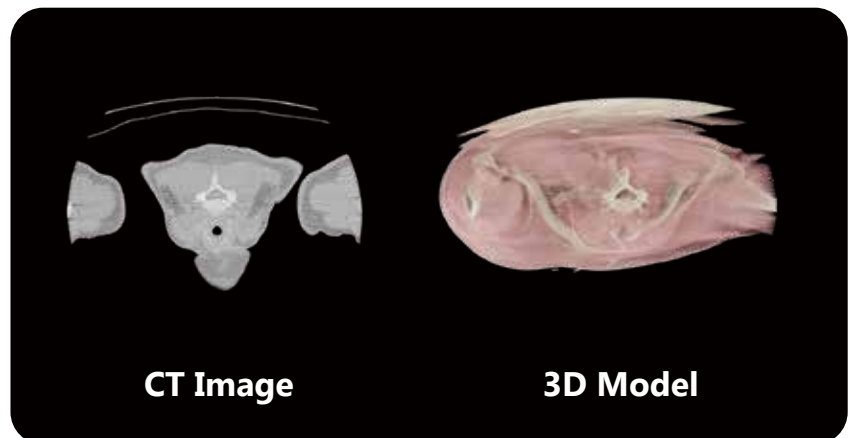

# Hardware Description

## TBK-43 LT



<b>CPU</b>	—————	<b>Intel i5</b>
<b>RAM</b>	—————	<b>16 GB</b>
<b>HDD</b>	—————	<b>1 TB</b>
<b>SSD</b>	—————	<b>240 GB</b>
<b>Screen size</b>	—————	<b>43 inch</b>
<b>Resolution</b>	—————	<b>1920 X 1080</b>
<b>Angle</b>	—————	<b>0° ~ 45°</b>

\* Taiwan Main Orthopaedic Biotechnology Co., Ltd. will upgrade the system for better performance at our own discretion.

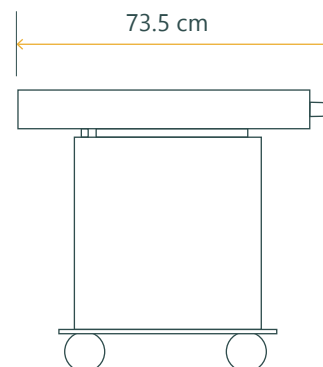
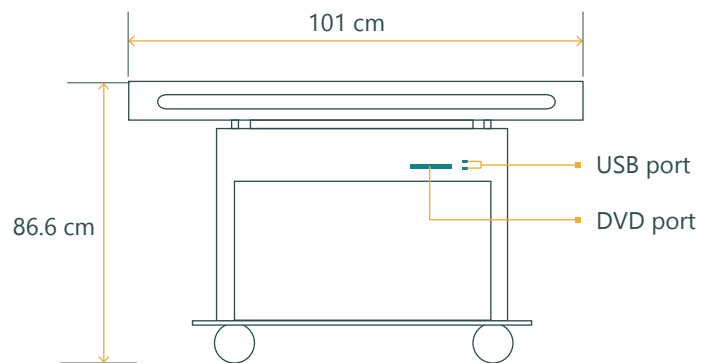
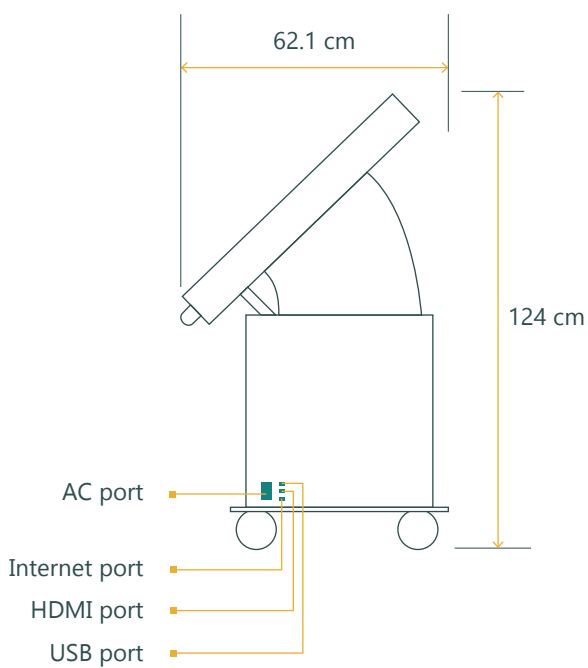

# TBK-65 4K

<b>CPU</b>	—————	<b>Intel i7</b>
<b>RAM</b>	—————	<b>16 GB</b>
<b>HDD</b>	—————	<b>6 TB</b>
<b>SSD</b>	—————	<b>1 TB</b>
<b>Screen size</b>	—————	<b>65 inch</b>
<b>Resolution</b>	—————	<b>3840 X 2160 (4K)</b>
<b>Angle</b>	—————	<b>0° ~ 90°</b>

\* Taiwan Main Orthopaedic Biotechnology Co., Ltd. will upgrade the system for better performance at our own discretion.

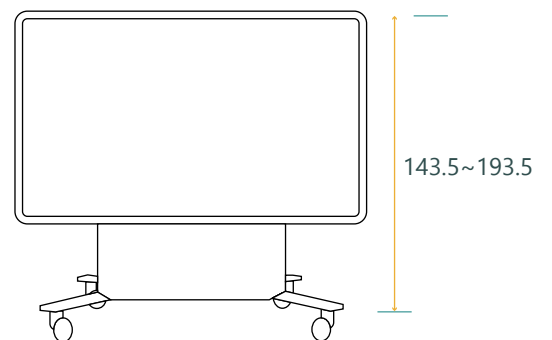
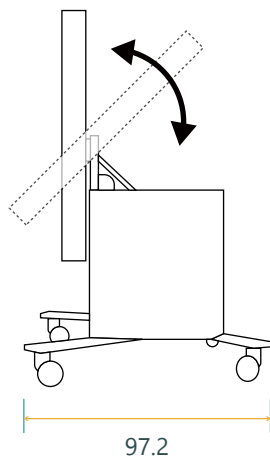
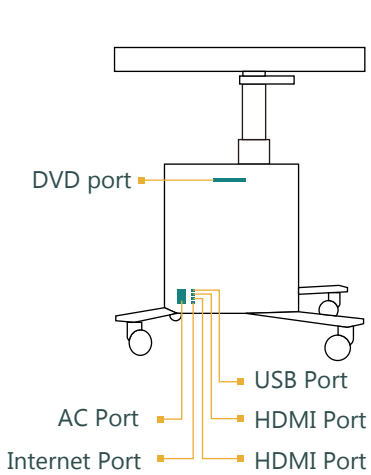
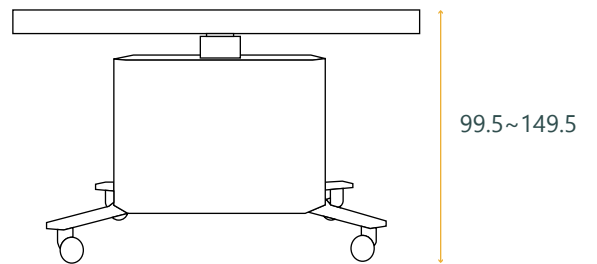
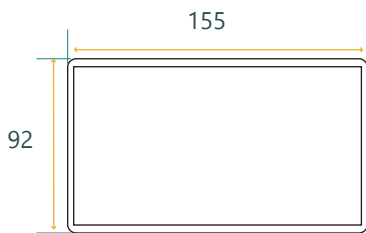

# Hardware Description

## TBK-84



<b>CPU</b>	—————	<b>Intel i7</b>
<b>RAM</b>	—————	<b>32 GB</b>
<b>HDD</b>	—————	<b>6 TB</b>
<b>SSD</b>	—————	<b>1 TB</b>
<b>Screen size</b>	—————	<b>84 inch</b>
<b>Resolution</b>	—————	<b>3840 X 1080</b>

\* Taiwan Main Orthopaedic Biotechnology Co., Ltd. will upgrade the system for better performance at our own discretion.

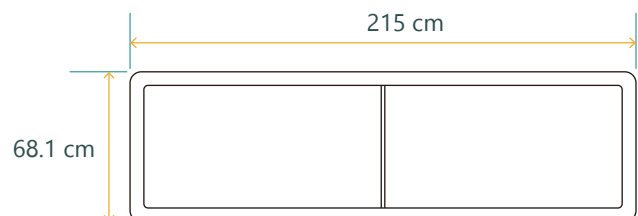
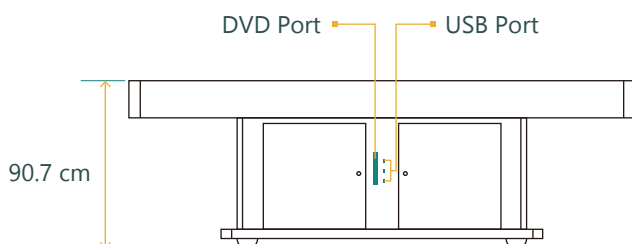
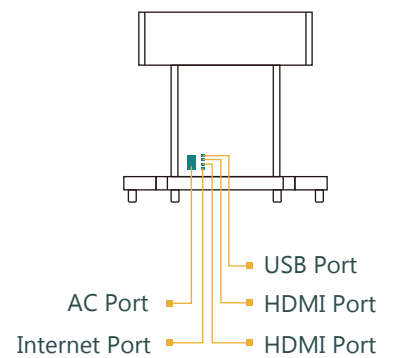

## TBK-84 EA



<b>CPU</b>	—————	<b>Intel i7</b>
<b>RAM</b>	—————	<b>32 GB</b>
<b>HDD</b>	—————	<b>6 TB</b>
<b>SSD</b>	—————	<b>1 TB</b>
<b>Screen size</b>	—————	<b>84 inch</b>
<b>Resolution</b>	—————	<b>3840 X 1080</b>
<b>Angle</b>	—————	<b>0° &amp; 90°</b>

\* Taiwan Main Orthopaedic Biotechnology Co., Ltd. will upgrade the system for better performance at our own discretion.

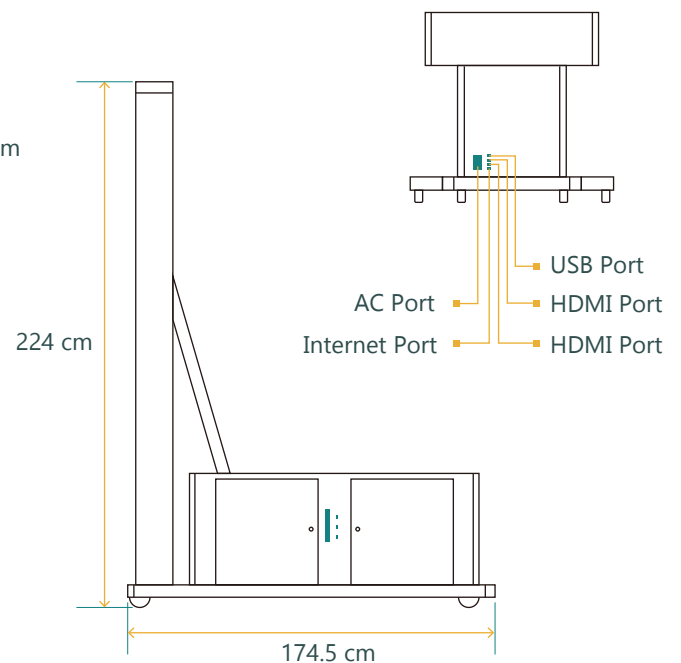
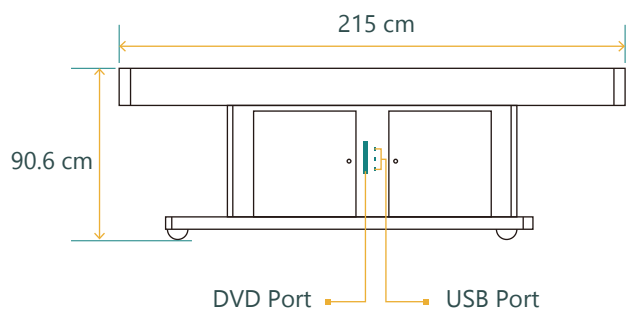
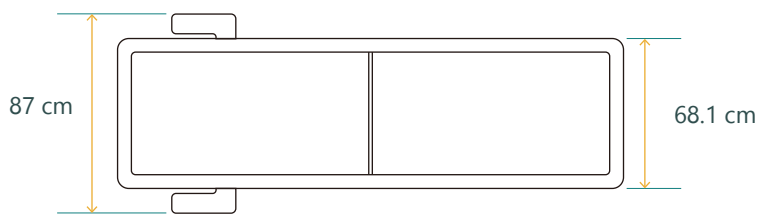

# Hardware Description

## TBK-99



<b>CPU</b>	—————	<b>Intel i9</b>
<b>RAM</b>	—————	<b>32 GB</b>
<b>HDD</b>	—————	<b>8 TB</b>
<b>SSD</b>	—————	<b>2 TB</b>
<b>Screen size</b>	—————	<b>99 inch</b>
<b>Resolution</b>	—————	<b>3840 X 1080</b>

\* Taiwan Main Orthopaedic Biotechnology Co., Ltd. will upgrade the system for better performance at our own discretion.

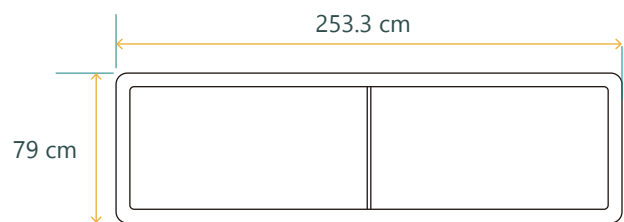
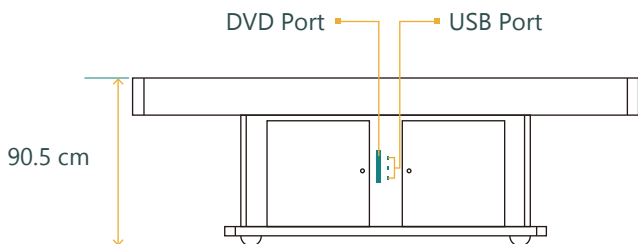
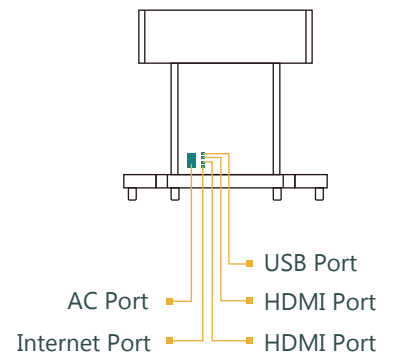



## TBK-99 EA



<b>CPU</b>	—————	<b>Intel i9</b>
<b>RAM</b>	—————	<b>32 GB</b>
<b>HDD</b>	—————	<b>8 TB</b>
<b>SSD</b>	—————	<b>2 TB</b>
<b>Screen size</b>	—————	<b>99 inch</b>
<b>Resolution</b>	—————	<b>3840 X 1080</b>
<b>Angle</b>	—————	<b>0° &amp; 90°</b>

\* Taiwan Main Orthopaedic Biotechnology Co., Ltd. will upgrade the system for better performance at our own discretion.

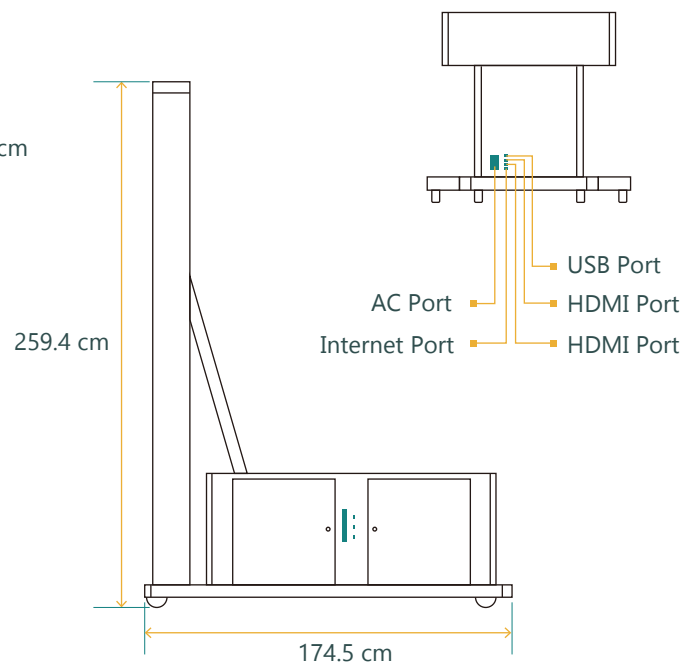
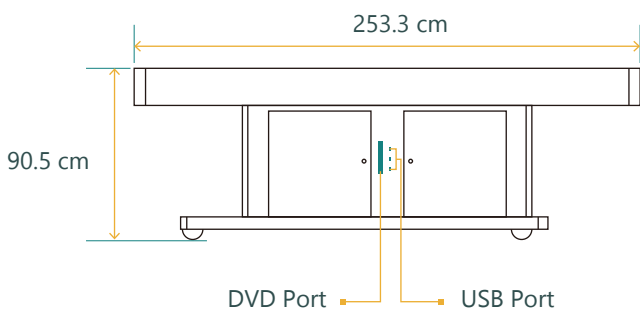
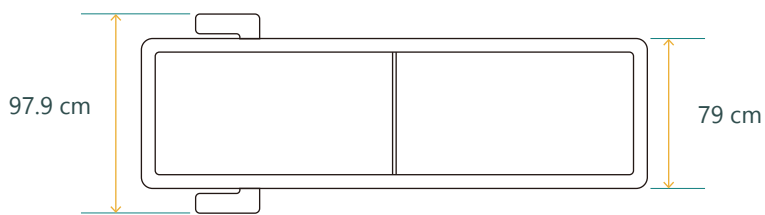

# Specification List

\* Taiwan Main Orthopaedic Biotechnology Co., Ltd. will upgrade the system for better performance at our own discretion.

	TBK-43 LT	TBK-65 4K	TBK-84	TBK-84 EA	TBK-99	TBK-99 EA
CPU	Intel i5	Intel i7	Intel i7	Intel i7	Intel i9	Intel i9
RAM	16 GB	16 GB	32 GB	32 GB	32 GB	32 GB
HDD	1 TB	6 TB	6 TB	6 TB	8 TB	8 TB
SSD	240 GB	1 TB	1 TB	1 TB	2 TB	2 TB
Screen size	43 inch	65 inch	84 inch	84 inch	99 inch	99 inch
Resolution	1920 X 1080	3840 X 2160 (4K)	3840 X 1080	3840 X 1080	3840 X 1080	3840 X 1080
Angle	0° ~ 45°	0° ~ 90°	-	0° & 90°	-	0° & 90°
Dimension (Horizontal)	101*73.5*86.6 cm	155*97.2*99.5~149.5 cm	215*68.1*90.7 cm	215*87*90.6 cm	253.3*79*90.5 cm	253.3*97.9*90.5 cm
Dimension (Wallboard / Vertical)	101*62.1*124 cm	155*97.2*143.5~193.5 cm	-	174.5*87*224 cm	-	174.5*97.9*259.4 cm
Software	Anatomy Radiology	Anatomy Radiology Histopathology Atlas CTRender	Anatomy Radiology Histopathology Atlas CTRender	Anatomy Radiology Histopathology Atlas CTRender	Anatomy Radiology Histopathology Atlas CTRender	Anatomy Radiology Histopathology Atlas CTRender



TBK-43 LT



TBK-65 4K



TBK-84 | TBK-99



TBK-84 EA | TBK-99 EA



**SURGLASSES**

[www.surglasses.com](http://www.surglasses.com)

Taiwan Main Orthopaedic Biotechnology Co., Ltd.

# ASCLEPIUS



**SURGLASSES**

**Taiwan Main Orthopaedic Biotechnology Co., Ltd.**

Tel +886 4-2565-2818

Fax +886 4-2565-3330

Email [info@surglasses.com](mailto:info@surglasses.com) | [tbk.sales@surglasses.com](mailto:tbk.sales@surglasses.com)

1F., No.46, Keya Rd., Daya Dist., Taichung City 428, Taiwan (R.O.C.)



**USA**

**American 3B Scientific**

Tel 888-326-6335

Email [sales@a3bs.com](mailto:sales@a3bs.com)

2189 Flintstone Drive, Suite 0, Tucker, Georgia 30084 U.S.A.